

SAGINAW CONTROL & ENGINEERING

SCE-72XR6618G

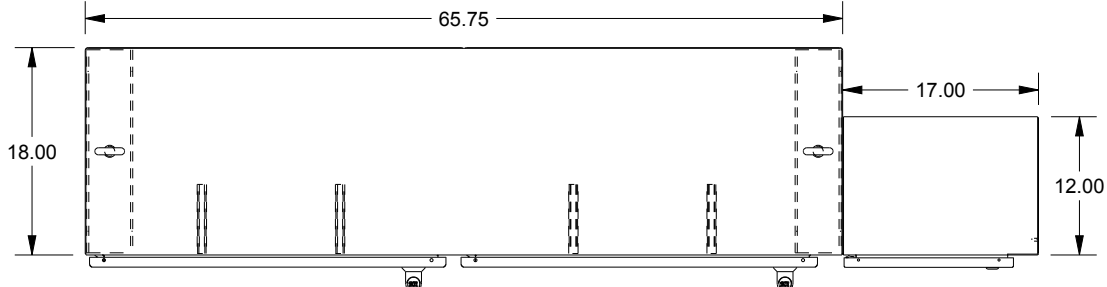

TOP VIEW

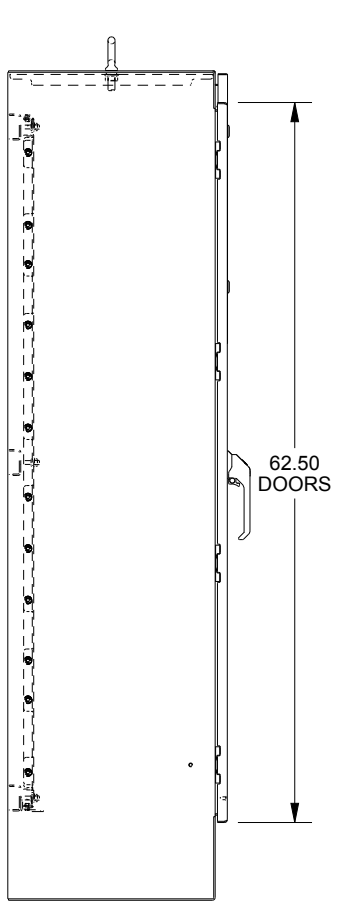

LEFT SIDE VIEW

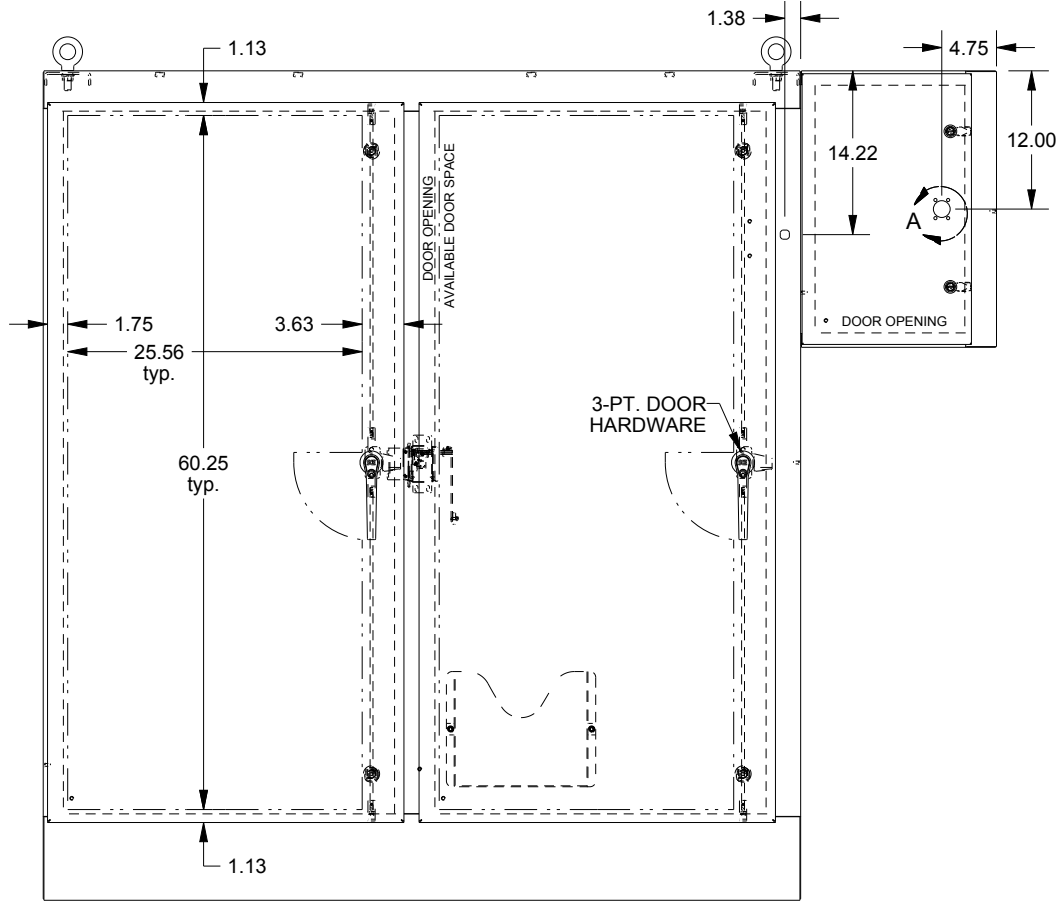

FRONT VIEW

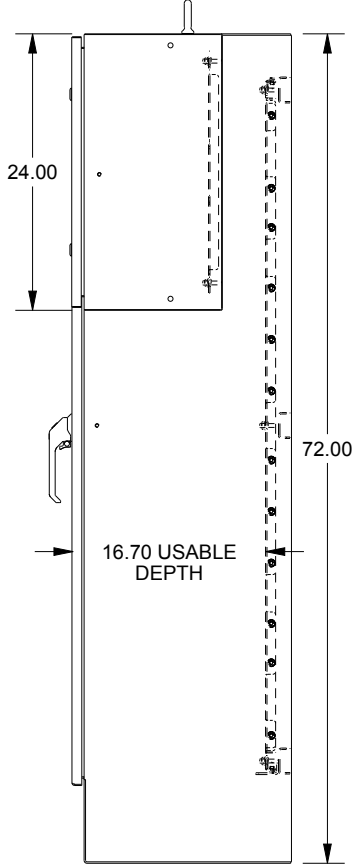

RIGHT SIDE VIEW

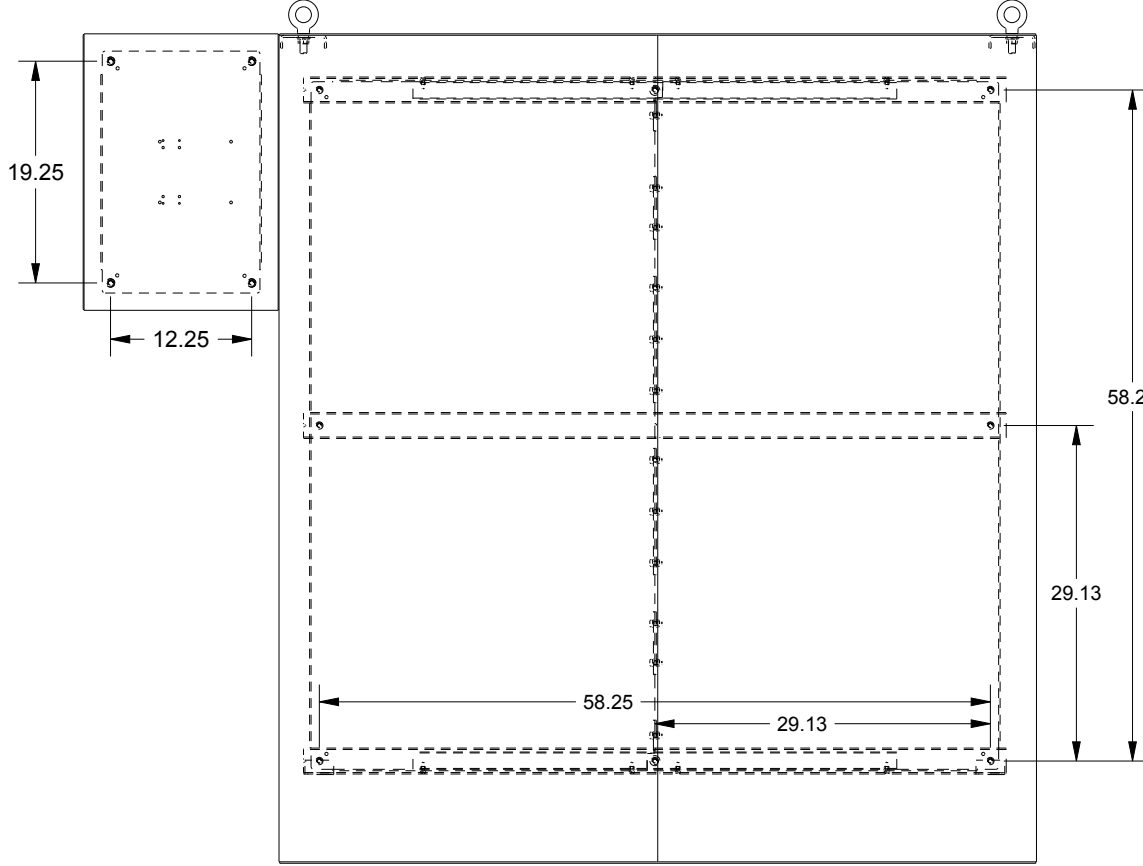

EXTERNAL REAR VIEW

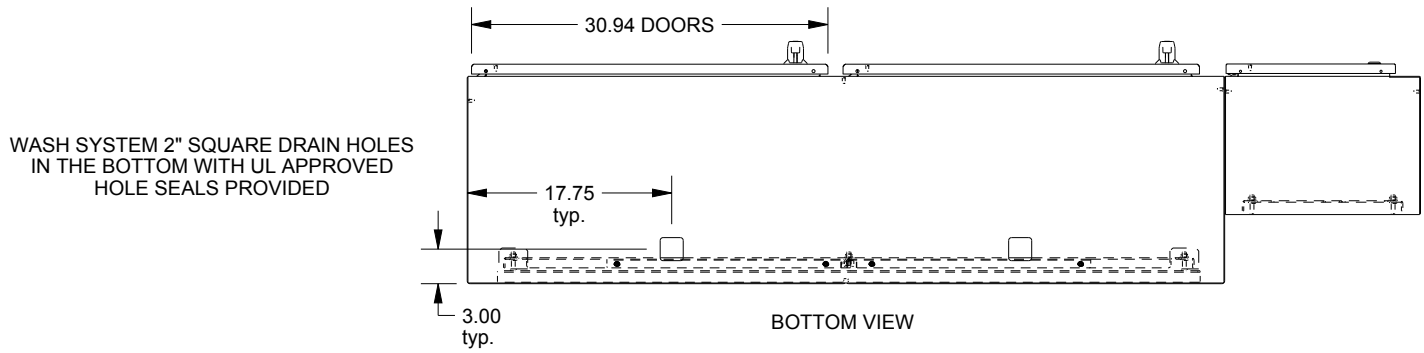

BOTTOM VIEW

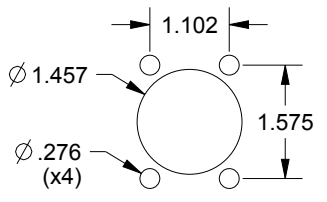

DETAIL A
SCALE 0.375